



AS Consultants

Marketing & Branding Solutions

PARTNER
COMPANIES



Company Profile 2021

Our Vision”

WE CREATE YOUR IMAGE

To be successful, you have to be able to relate to people; you have to **inspire the spirit, penetrate the heart, and ignite the mind.**



Amin M.Sammour

Business Consultant



Our Mission

Who We Are

**WE ENHANCE
YOUR
BUSINESS**



DESIGN , PROTOTYPE, AND BRING TO LIFE meaningful products, services and strategies on a global basis that can drive dramatic breakthroughs in delivering profitable growth in challenging start-up and high growth organizations



Our Services

What We Do

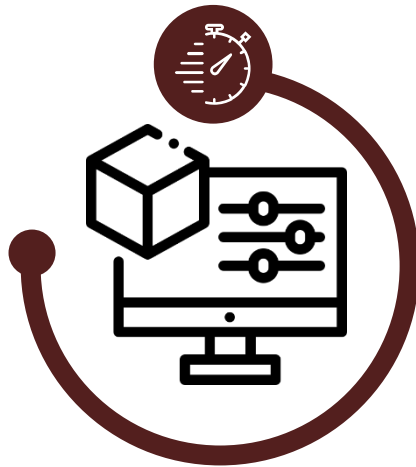

CG Production Services

- 3D Productions.
- 3D Scans & Camera Walkthrough
- VR & AR Implementation.
- White-board & Explainer Ads
- Visual Presentations.



Business Consultations & Development

- Business Planning & Feasibility Studies
- Market Research Studies
- Market, Competitors & Industry Analysis reports



Marketing , Branding & Identity Solutions

- Company & Product Branding
- Graphic Design
- Web Development and Design
- Social Media Solutions

Marketing & Branding Solutions

Logo Design , Company Profiles , Stationary , Flyers , Brouchers , Roll ups

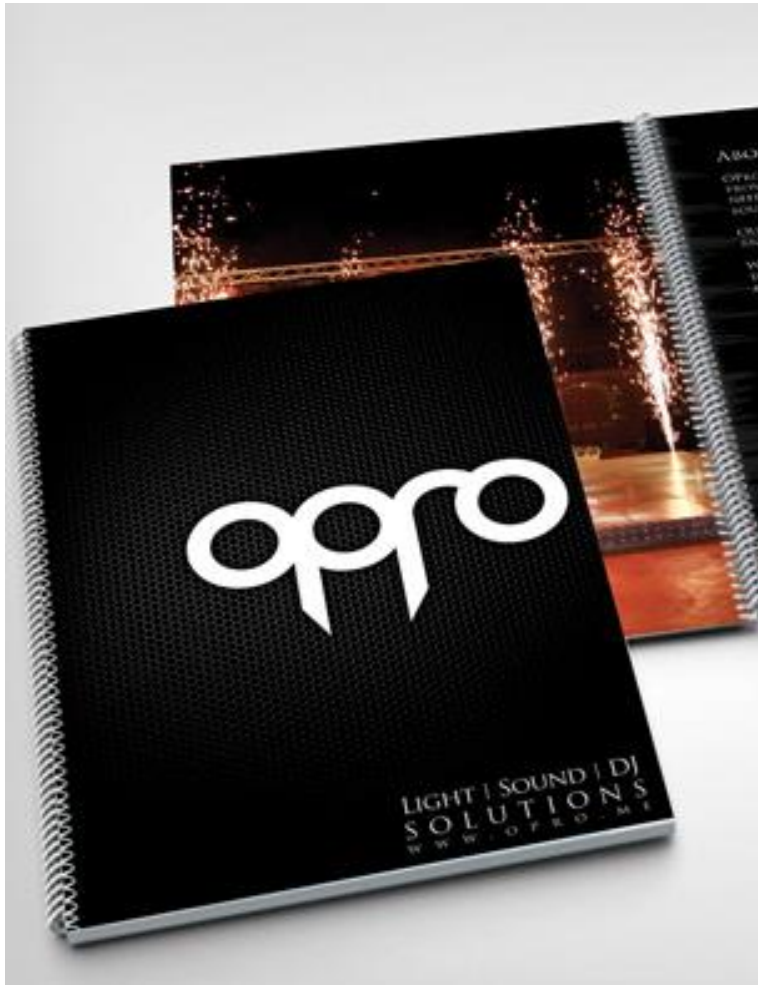

A brand is the essence of one's own unique story, it is the sub-total of all the "experiences" your customers have with your business. The products, services, and technologies might be impressive, but at the end of the day, the brand is what people remember you by. It ties to the hearts of your customers and helps to maintain their loyalty.

We will be creating your brand image, through various sample of the design, working closely with your good company to create new uplifting spirit for your brand .



Marketing & Branding Solutions

Logo Design



Marketing & Branding Solutions

Logo Design

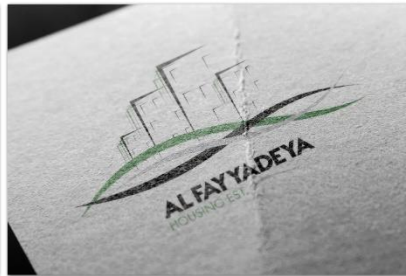

Marketing & Branding Solutions

Logo Design



جوعان.. معنا شبعان



Never stay hungry



Tik Tok... It's Lunch Time



جوعان.. معنا شبعان



Never stay hungry



تيك توك.. دقت الساعة

Font:
Exo 2 Bold Condensed

العربي
SwissraCondensed-Normal

Slogan:
Never stay hungry
It's launch Time
جوعان.. خسا الجوع



Marketing & Branding Solutions

Logo Design

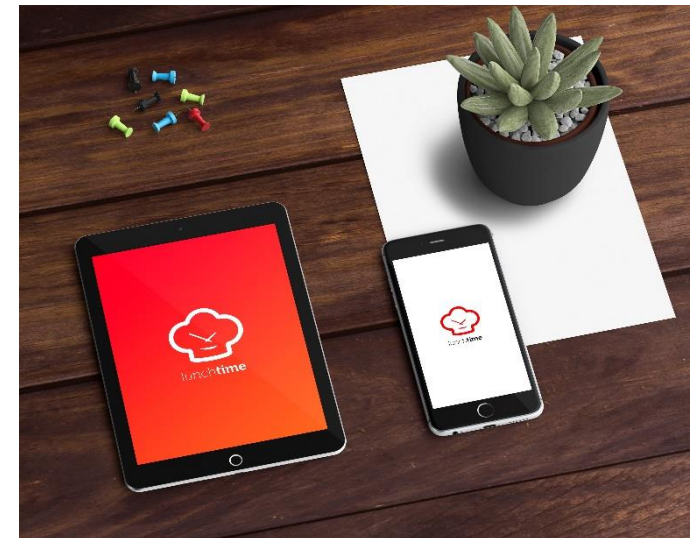
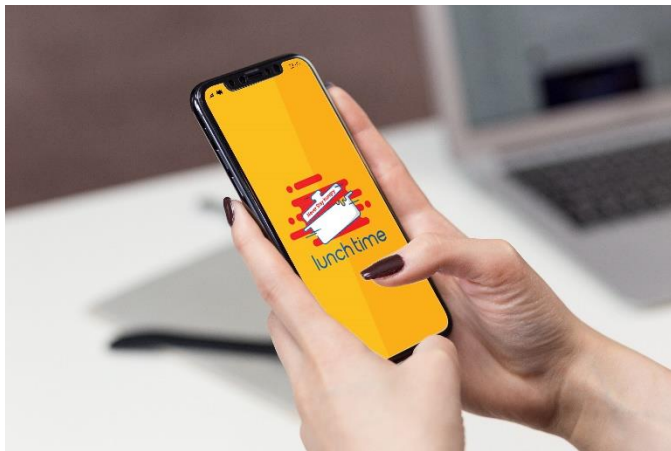
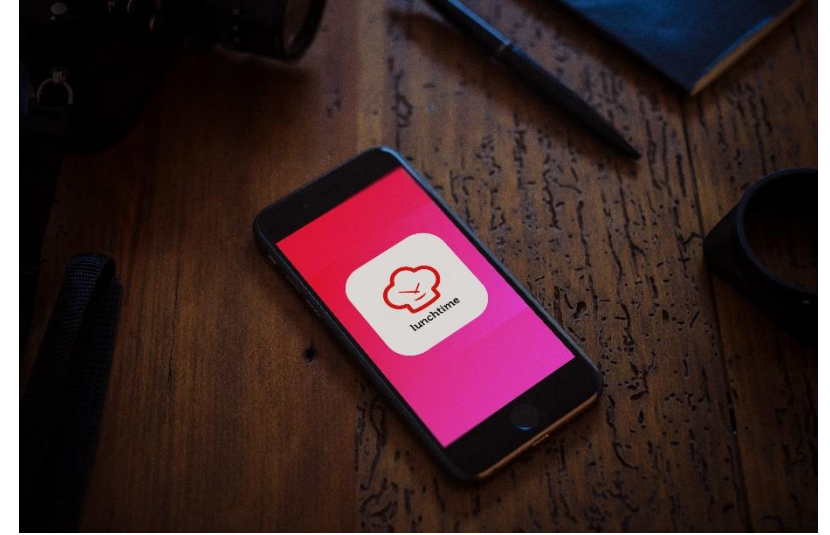

Marketing & Branding Solutions

Logo Design

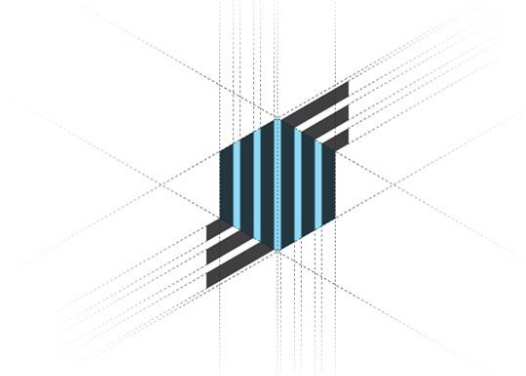

Marketing & Branding Solutions

Stationary



Marketing & Branding Solutions

Stationary



Marketing & Branding Solutions



HAWLER
Travel & Tours

Marketing & Branding Solutions

Stationary



Marketing & Branding Solutions

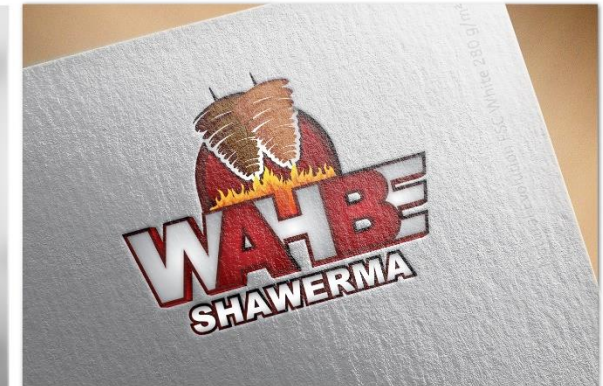

Marketing & Branding Solutions

Roll ups , Flyers , Brochures



Marketing & Branding Solutions

Roll ups , Flyers , Brochures ,Signage



Marketing & Branding Solutions

Roll ups , Flyers , Brochures, signage

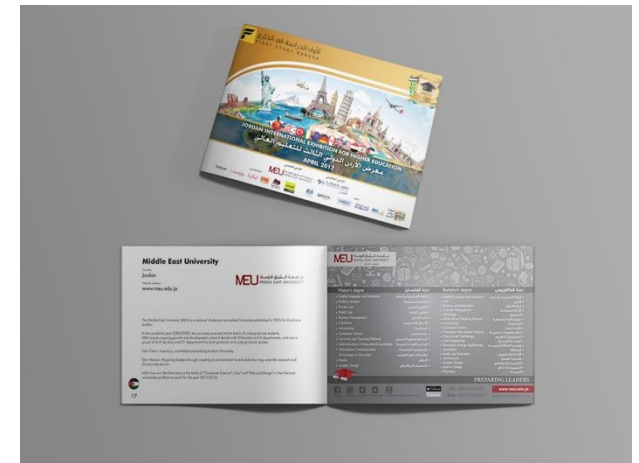
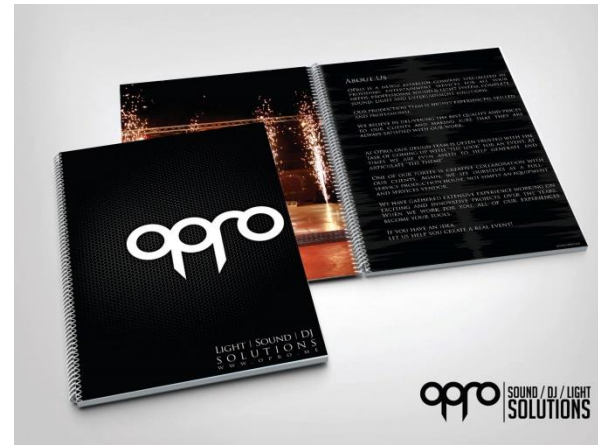

Marketing & Branding Solutions

Roll ups , Flyers , Brochures ,Signage

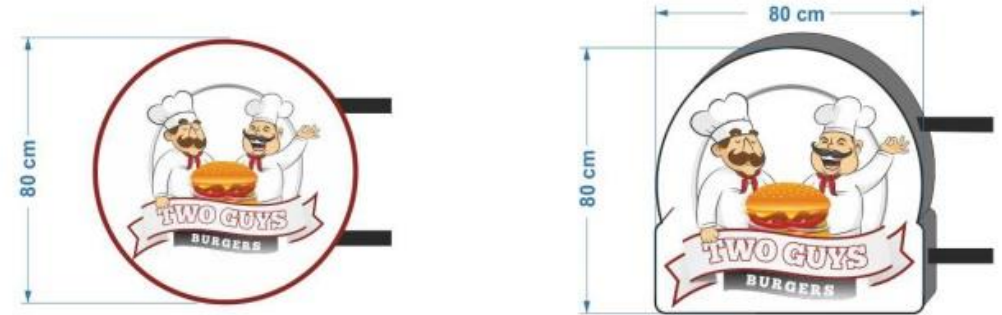

Website Design & Development

Fresh new responsive design, to be fitted for all types of devices

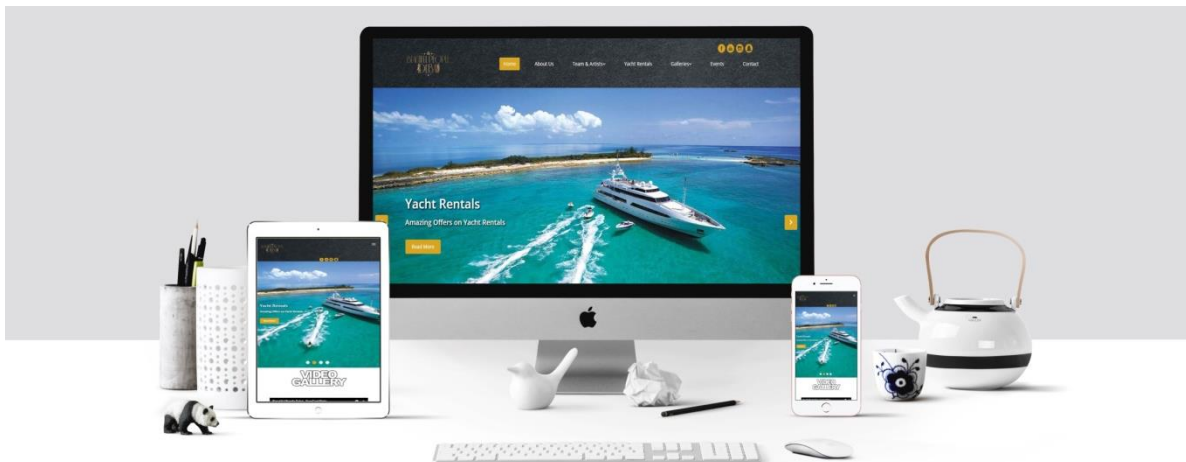

- Designing wireframe and page mockup.
- Building the Content.
- Functional prototype.
- Search engine optimization (SEO)



Website Design & Development

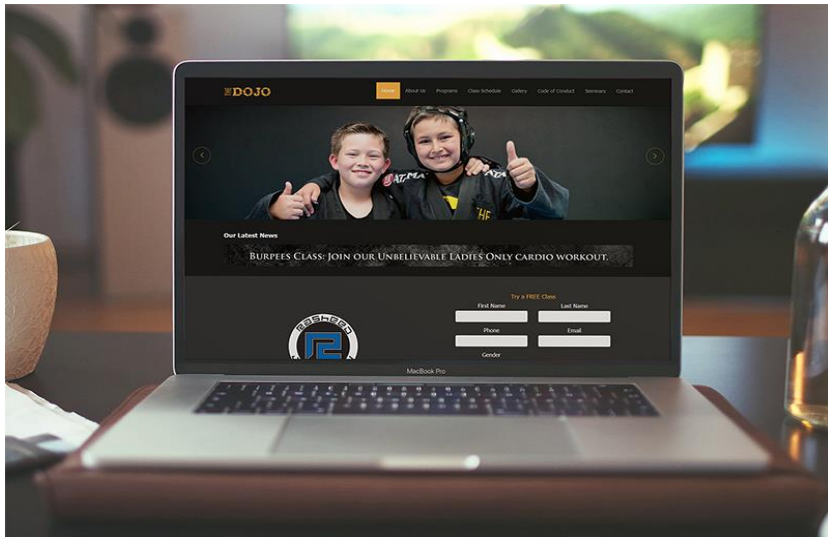
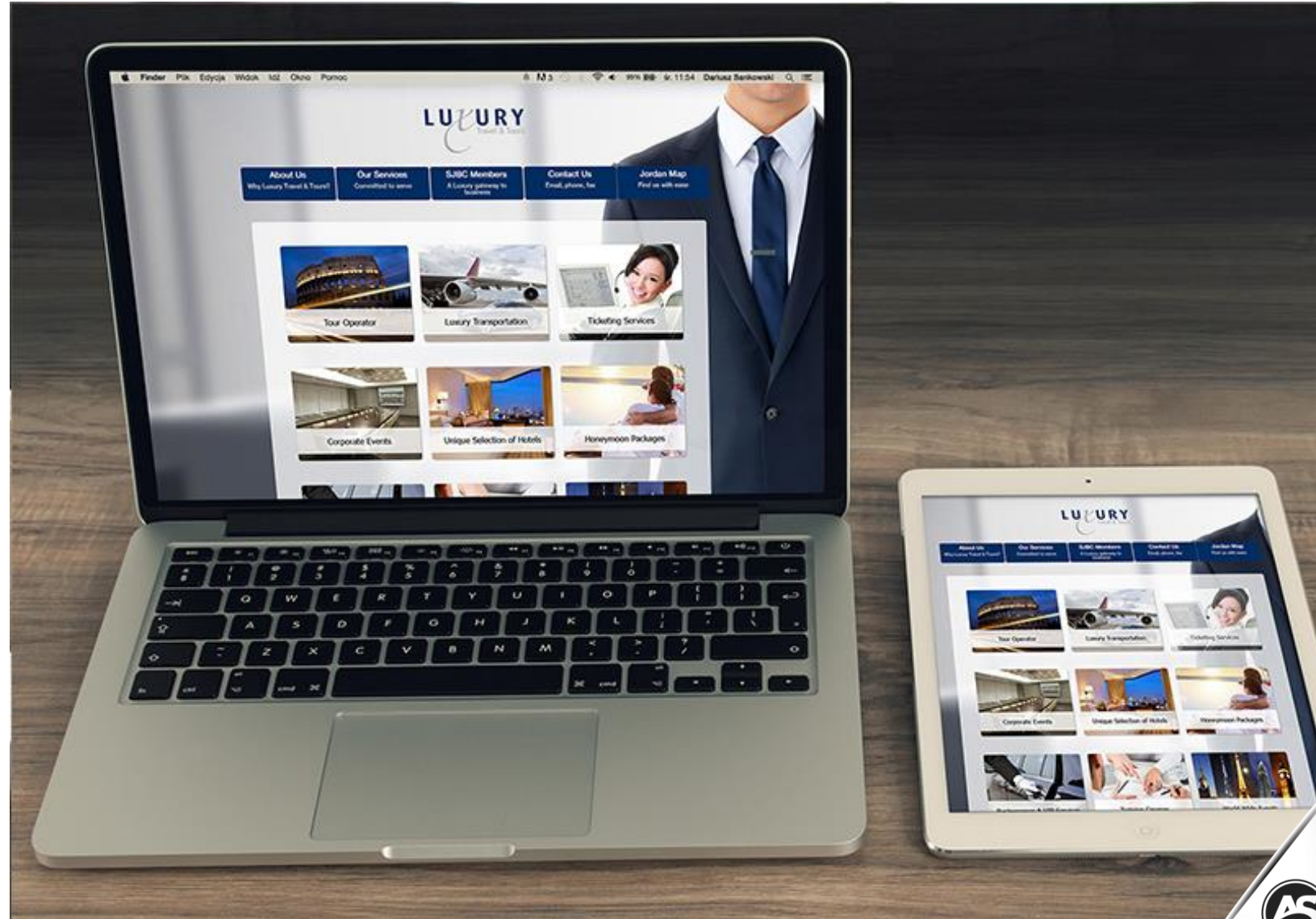

Website Design & Development

- 1
Luxury Travel & Tours
www.luxurytours.jo.com
- 2
Beautiful People Dubai
www.beautifulpeopledubai.com
- 3
Xenia Hospitality Consultants
www.xeneajo.com
- 4
Dojo Academy
www.thedojoacademy.com
- 5
Majdalawi University services
www.majdalawi-mus.com

- 6
Shiffar Company
www.shifar.com
- 2
Khaldun Albaz
www.khaldunAlbaz.com
- 8
AlFayyadayea Construction
www.alfayyadeya.com
- 9
Edu Group Arabia
www.EduGroup-Arabia.com
- 10
Alnool Company
www.alnool.com



Social Media Solutions

We help you to take the plunge gracefully in the social media market and establish a firm position for your brand.

- 1 Creating Engaging Social Content
- 2 Posting Company-Related Updates
- 3 Promotions & Social Campaigns
- 4 Integrate Social Media Activity into Other Marketing Plans
- 5 Monitoring
- 6 Analytics
- 7 ORM (Online Reputation Management)



Marketing & Branding Solutions

Social Media Advertisement Campaigns

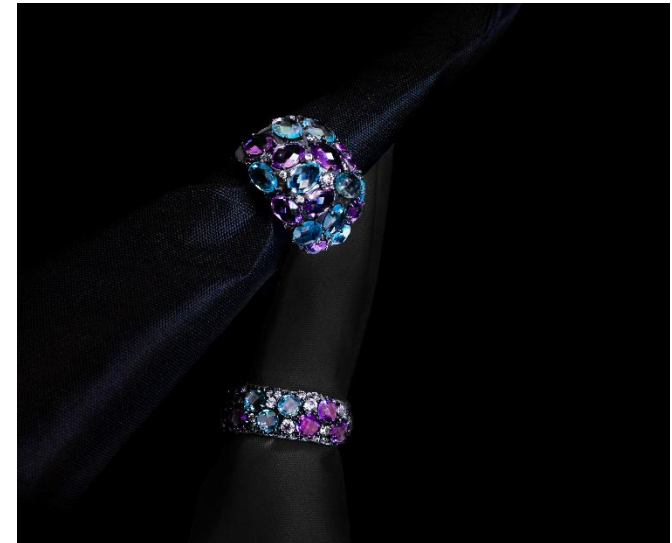

Marketing & Branding Solutions

Social Media Advertisement Campaigns



Marketing & Branding Solutions

Social Media Advertisement Campaigns



بكبسة زر أكلك واصل عندك كل يوم

وجبة واحدة
39 دينار/أسبوع 140 دينار/شهر

ثلاث وجبات
88 دينار/أسبوع 320 دينار/شهر

The advertisement shows a plate of Kabasa Zor (meat and rice) and a set of three meals (three plates with rice and meat). The prices are listed in a table format.

صمم جدول أكلك

زرب	منسف
مسخن	قدرة
كبسة	مندي
كفتة بالطصينة	كفتة بالبندورة
أوزي	بخاري
دجاج بالفطر والكرما	صيني

زوروا صفحتنا
@LunchTimeD

The advertisement shows a bowl of rice and meat. The menu items are listed in a table format.

بكبسة زر أكلك واصل عندك كل يوم

وجبة واحدة 39 دينار/أسبوع 140 دينار/شهر	وجبتين 63 دينار/أسبوع 240 دينار/شهر	ثلاث وجبات 88 دينار/أسبوع 320 دينار/شهر
--	--	--

التصانيف الصحية

سندويش صدور دجاج اختيار السمين x2	برغر صحي x2	سمك	صدور دجاج	سنيك
-----------------------------------	-------------	-----	-----------	------

زوروا صفحتنا
@LunchTimeD

The advertisement shows a bowl of rice and meat. The menu items are listed in a table format.

Marketing & Branding Solutions

Social Media Advertisement Campaigns

return on investment till **8%**

STARTING FROM **1.1M** AED

شبابيك
SHABABEEK REAL ESTATE

+971555592484 +966504658378

SHREDUBAI @SHABABEEK_REAL_ESTATE SHABABEEKDUBAI.COM

دبي
تفتح ذراعيها
لك ولعائلتك

استعار تبدأ من **1,250,000** درهم فقط

7 سنوات خطط سداد مرنة

10% دفعة اولى فقط

تسليم 2019 / 6

10% دفعة اولى

أحمد الهبابك
Ahmed Elhabbak

00971568824468

شبابيك
SHABABEEK REAL ESTATE

+971555592484 +966504658378

SHREDUBAI @SHABABEEK_REAL_ESTATE SHABABEEKDUBAI.COM

نخلة الجميرا
عنوانك الرائع

شقق جاهزة
للتسليم فوراً

7 سنوات خطط سداد مرنة

10% دفعة اولى فقط

شبابيك
SHABABEEK REAL ESTATE

+971555592484 +966504658378

SHREDUBAI @SHABABEEK_REAL_ESTATE SHABABEEKDUBAI.COM

استعار تبدأ من **383,000**

1% أمشاط شهرية

10% دفعة اولى فقط

سداد لأقابة 6 سنوات

شبابيك
SHABABEEK REAL ESTATE

+971555592484 +966504658378

SHREDUBAI @SHABABEEK_REAL_ESTATE SHABABEEKDUBAI.COM

الأسعار تبدأ من **395,000**

ستوديو - غرفة نوم 2 - 1

شبابيك
SHABABEEK REAL ESTATE

+971555592484 +966504658378

SHREDUBAI @SHABABEEK_REAL_ESTATE SHABABEEKDUBAI.COM

تبدأ الاسعار من **570** الف درهم

شبابيك
SHABABEEK REAL ESTATE

+971555592484 +966504658378

SHREDUBAI @SHABABEEK_REAL_ESTATE SHABABEEKDUBAI.COM

انتقل فوراً الى منزل عائلتك الجديد ..

21% عائد مضمون
بالعقد خلال
3 سنوات

4 غرف نوم

شبابيك
SHABABEEK REAL ESTATE

+971555592484 +966504658378

SHREDUBAI @SHABABEEK_REAL_ESTATE SHABABEEKDUBAI.COM

عش او استثمر في أرقى مجمع
تاون هاوس في دبي

5% دفعة اولى فقط

3+2 غرف نوم

أمشاط 5 سنوات بعد التسليم

شبابيك
SHABABEEK REAL ESTATE

+971555592484 +966504658378

SHREDUBAI @SHABABEEK_REAL_ESTATE SHABABEEKDUBAI.COM

Marketing & Branding Solutions

Social Media Advertisement Campaigns



IDEAL SOLUTION
شركة الحل المثالي العقارية
REAL ESTATE

تملك عقارك
في قرية الجميرا في دبي

قسط شهري 340 دينار
مؤثت بالكامل
مسبح ونادي صحي وأمن على مدار الساعة

+965 51122328 +965 66602007 @kuwait_dubai



IDEAL SOLUTION
شركة الحل المثالي العقارية
REAL ESTATE

كابيتال إيكونوميكس
3.5% نمواً متوقعاً في اقتصاد الإمارات خلال 2019

+965 51122328 +965 66602007 @kuwait_dubai



IDEAL SOLUTION
شركة الحل المثالي العقارية
REAL ESTATE

افضل نظام
تقسيت في دبي

عائد سنوي 10%
أجر عقارك وسدد أقساطك
عدد محدود جداً

+965 51122328 +965 66602007 @kuwait_dubai

Marketing & Branding Solutions

Social Media Advertisement Campaigns



PARIS OFF-SEASON. SHANGRI-LA INCREDIBLY LOW PRICES.



NEW YORK OFF-SEASON. SHANGRI-LA INCREDIBLY LOW PRICES.

Business Consultation & Development



Every business needs a plan, a strategy that defines your vision, your goals and how you are going to reach them. Whether you are a new business owner, or already have a small business, a simple business strategy can take your business to the next level.

We will help you to

- 1 Clarify your Vision**
- 2 Explore right business model for your business**
- 3 Brainstorm on new products and services**
- 4 Scope out the competition**
- 5 Set your revenue and expense model**
- 6 Craft long-term and short-term goals**
- 7 Determine which staff or subcontractors to hire**
- 8 Find more efficient ways to run your office**
- 9 Design your brand**



Business Consultation & Development

Reinventing your business and penetrating New Market Space

based on a decade-long study of more than 150 strategic moves spanning more than 30 industries over 100 years. systematic tools and frameworks that pursue differentiation and low cost. to break away from the competition & make the competition irrelevant by reconstructing industry boundaries

Forecast the future revenues and expenses for your business

Sales forecast, cost of sales ,Income statement, balance sheet ,cash flow ,financial requirements & performance indicators.

Promote your product or service through different media, including television, radio, print and online platforms

We help you to:

- Determining if there is a paying market for your products and services
- Crafting long-term and short-term marketing goals
- Defining marketing campaigns
- Creating marketing strategies
- Selecting powerful marketing techniques that showcase your products and services
- Choosing a brand and image that reflects the real YOU
- Designing marketing materials
- Designing Internet marketing strategies
- Tracking marketing results to determine the strongest techniques



We Help you to determine whether your business idea is a viable option.

Building a business model , defining a target market , operation strategy and tactics ,Marketing and sales plan ,Management & HR structure and a financial plan.

We Help you to asses the target market & consumer interest before launching Your product or service

Insightful report , Facts & Figures , Market size & market trends , Forecast growth opportunities , identify market segmentation & consumer needs , product differentiation

Flag the competitors In your market and devise a way To compete against them.

SWOT Analysis , Porter's 5- Forces analysis , PEST(LE) analysis ,Ansoff Matrix Analysis , ERRC Grid & Mckinsey 7 "s" model.



Business Consultation & Development

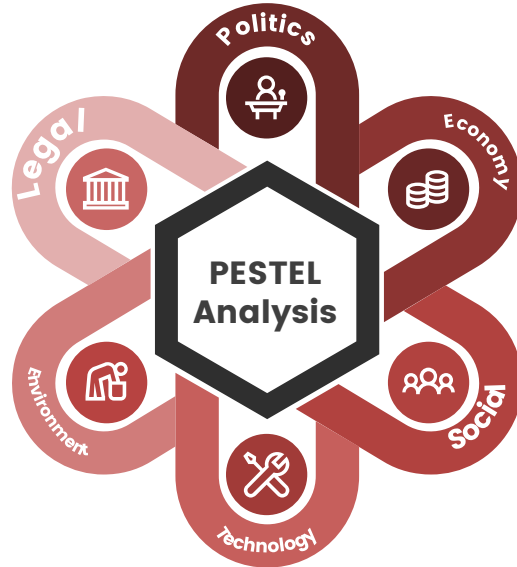
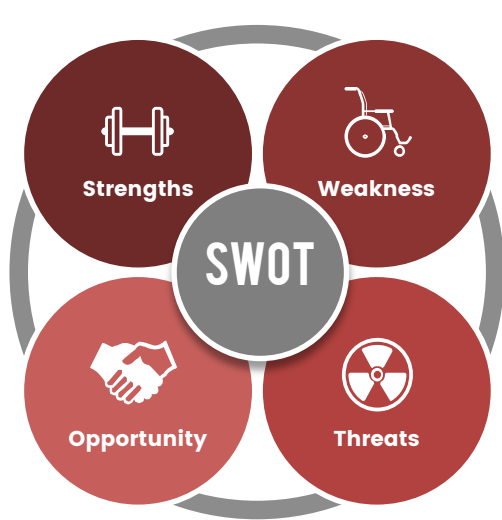

	EXISTING	NEW
EXISTING	 Market Penetration	 Product Development
NEW	 Market Development	 Diversification

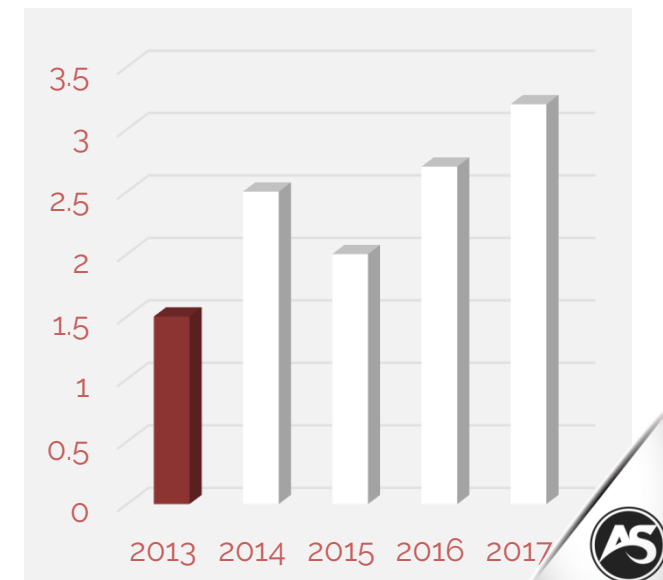
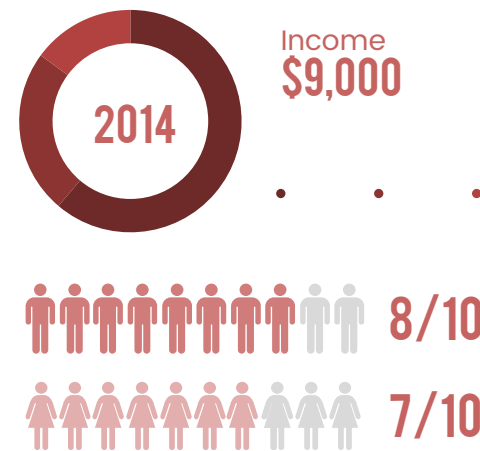
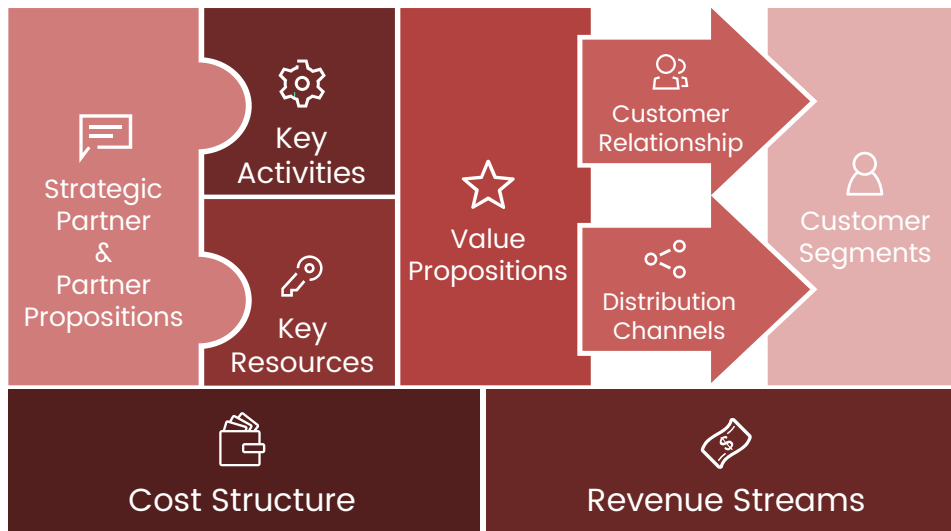
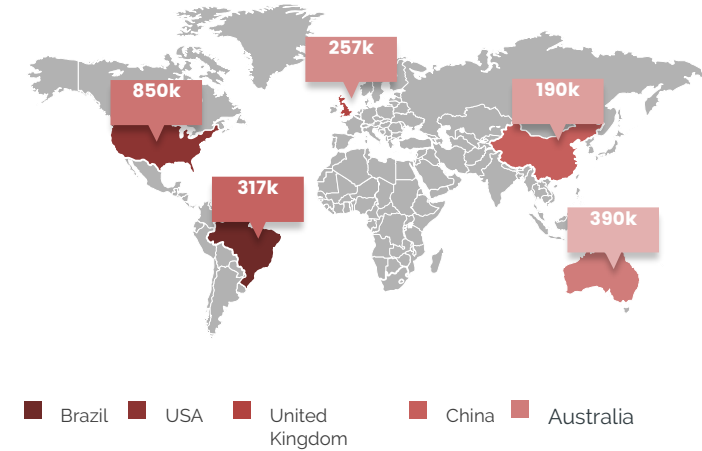

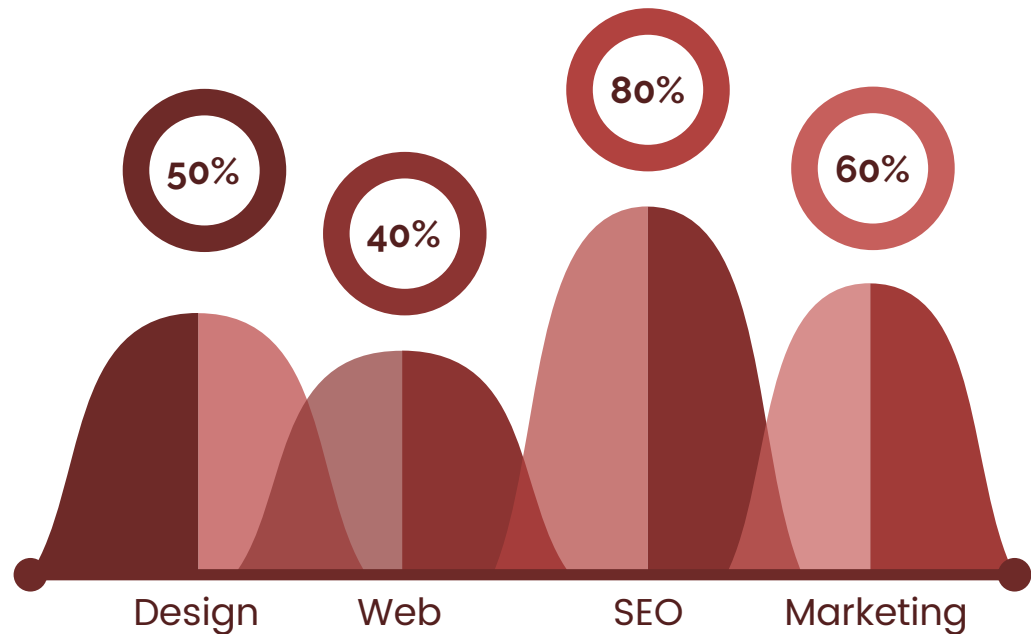
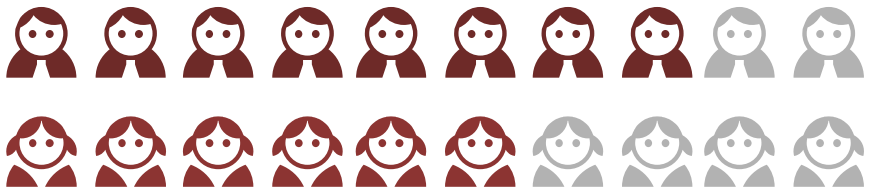
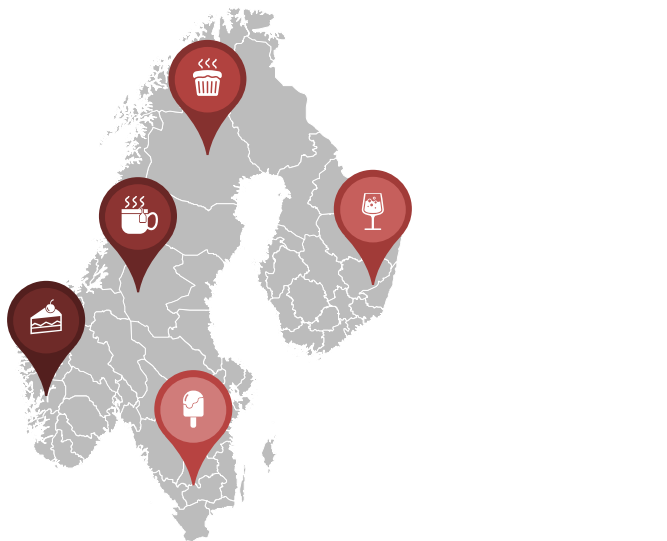
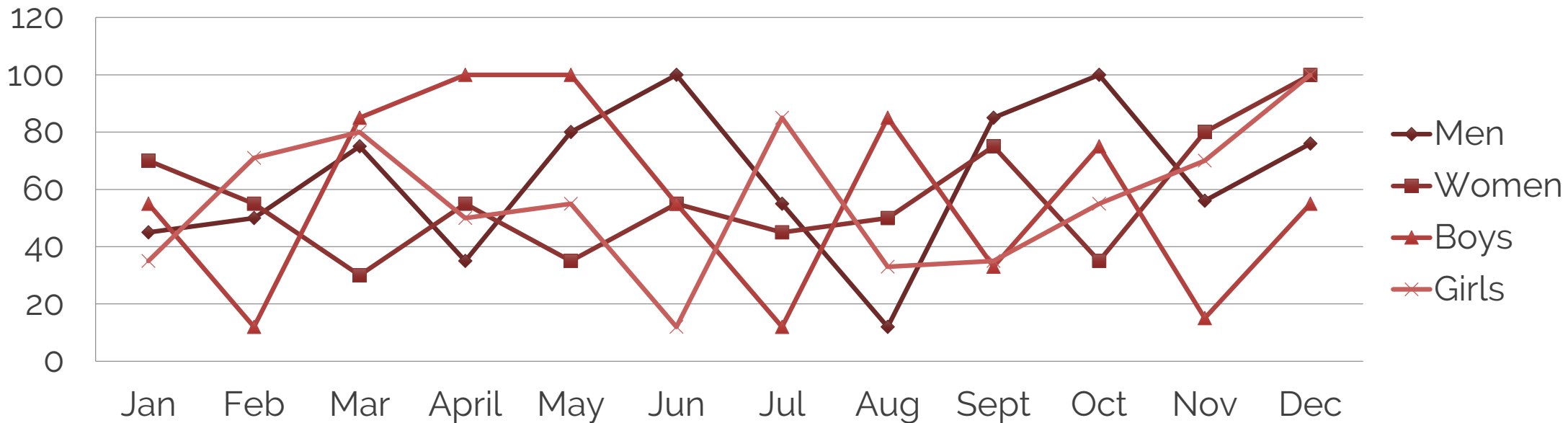

Overall

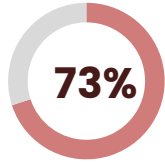

User



237,500\$

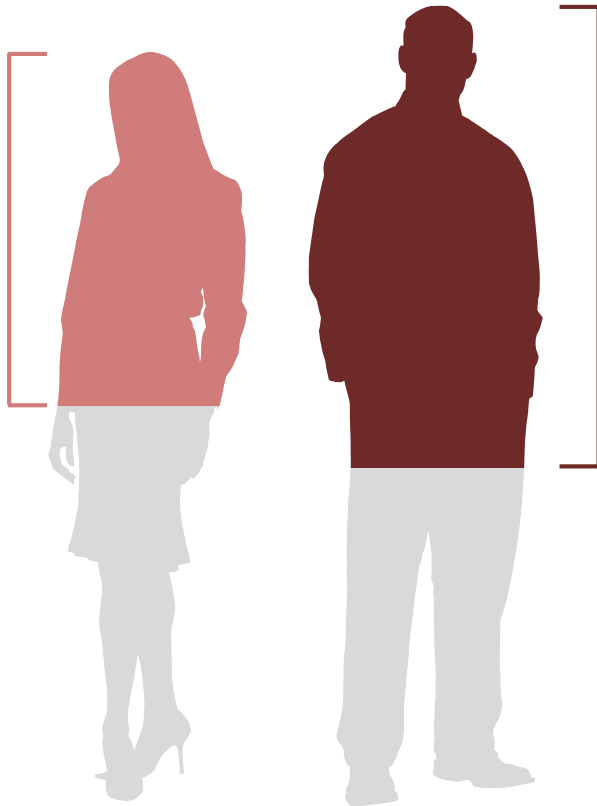

Overall

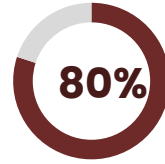

User



\$237,500

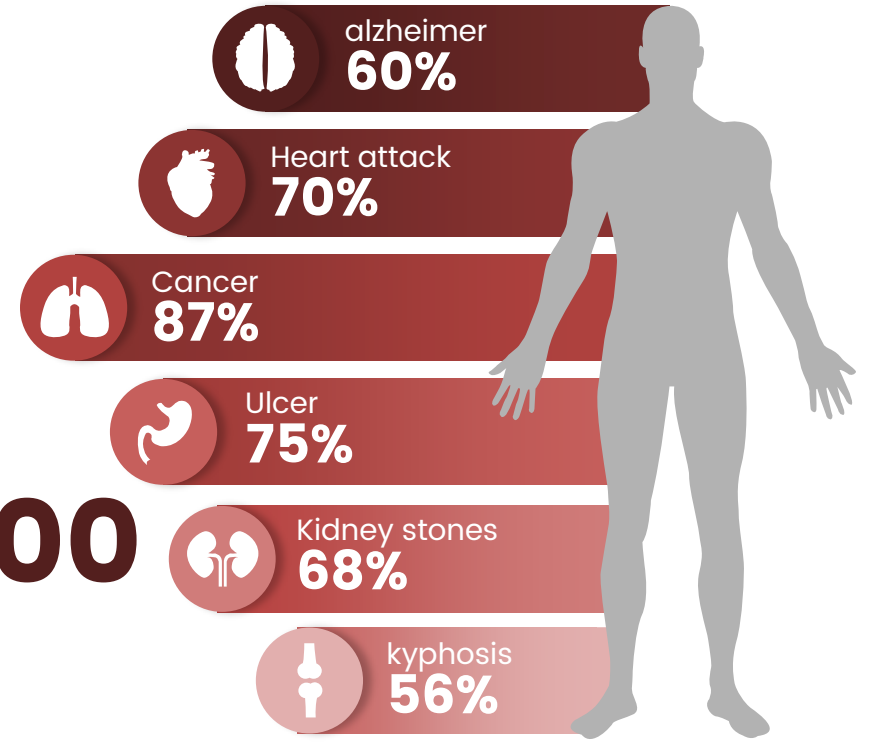

40%

35%

25%



Logo



Webdesign



SEO



Marketing

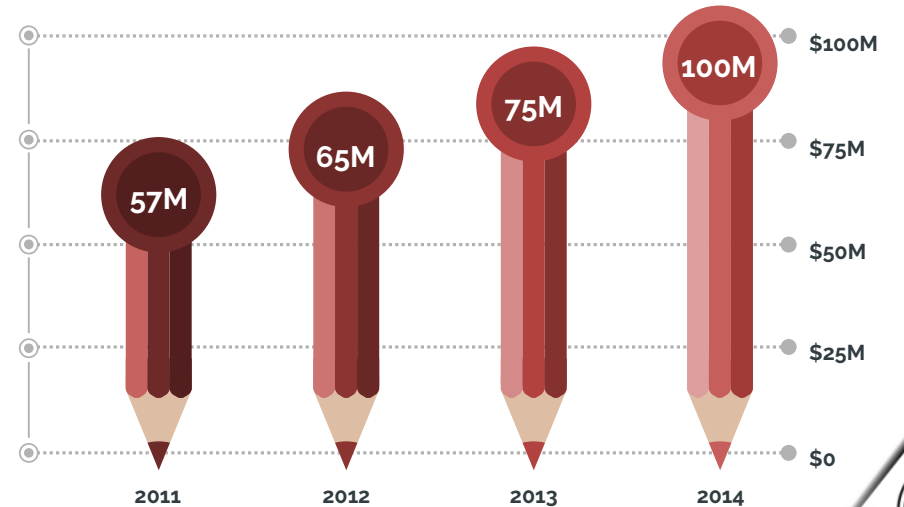

Blue Ocean Strategy Framework

From assessing the current state of play in an industry, to exploring the six paths to new market space, to understanding how to convert noncustomers into customers. Blue Ocean Strategy provides a clear four-step process to create uncontested business strategy .

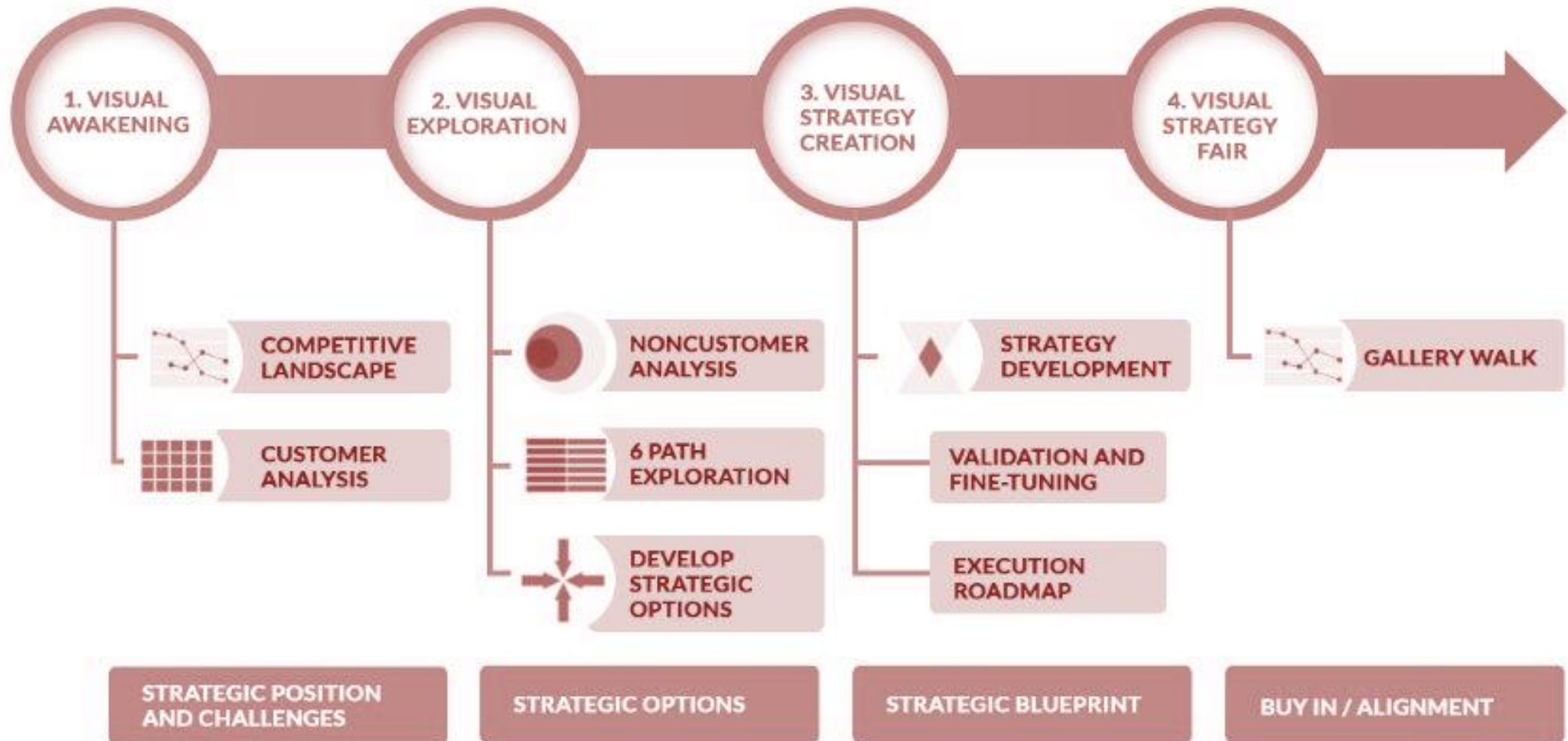



CG Production Services

3D Visualization , Camera Walkthrough , Visual effects and post production



3D Productions

create a photorealistic image of exterior and interior building , from schematic representation with simple geometry to complex objects with thoroughly recreated details.

- Creation of 3D models and assets
- Rendering & Animation
- VFX and Motion Graphics





CG Production Services

3D Visualization , Camera Walkthrough , Visual effects and post production

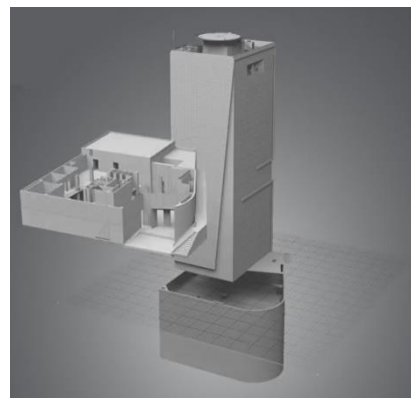



CG Production Services

3D Visualization , Camera Walkthrough , Visual effects and post production



CG Production Services

3D Visualization , Camera Walkthrough , Visual effects and post production





CG Production Services

3D Visualization , Camera Walkthrough , Visual effects and post production



CG Production Services

3D Visualization , Camera Walkthrough , Visual effects and post production



CG Production Services

3D Visualization , Camera Walkthrough , Visual effects and post production





CG Production Services

3D Visualization , Camera Walkthrough , Visual effects and post production





CG Production Services

3D Visualization , Camera Walkthrough , Visual effects and post production





CG Production Services

3D Visualization , Camera Walkthrough , Visual effects and post production



CG Production Services

3D Visualization , Camera Walkthrough , Visual effects and post production



CG Production Services

3D Visualization , Camera Walkthrough , Visual effects and post production



CG Production Services

3D Visualization , Camera Walkthrough , Visual effects and post production





CG Production Services





CG Production Services



CG Production Services

3D Visualization , Camera Walkthrough , Visual effects and post production





CG Production Services

Visual Presentations , Promotional Videos , White board Ads . Company profile videos

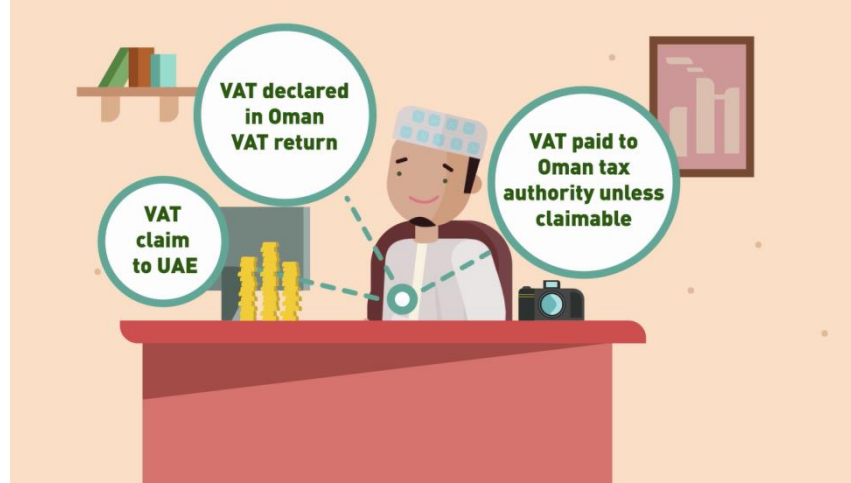

Beautiful compelling visuals, with a clear structure, help your audiences to understand and remember your content.

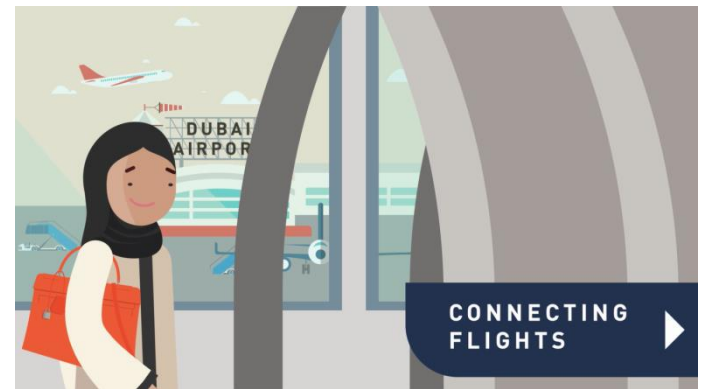
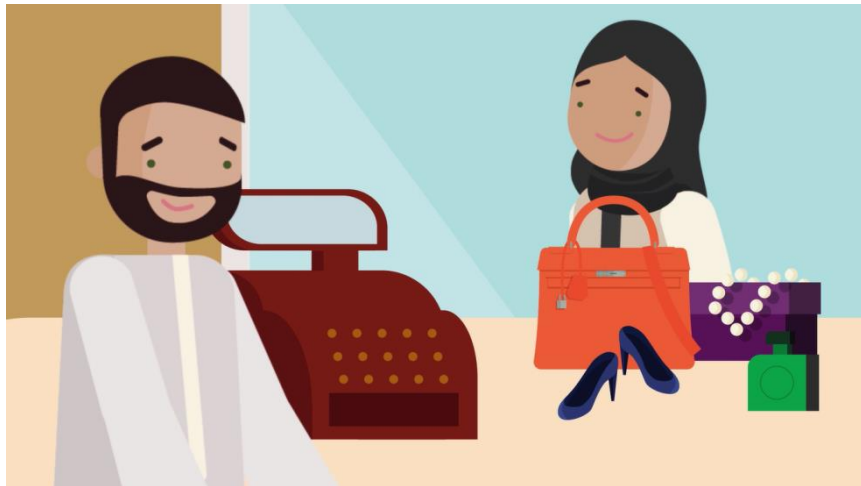



CG Production Services

Character Design , Promotional Videos , White board Ads

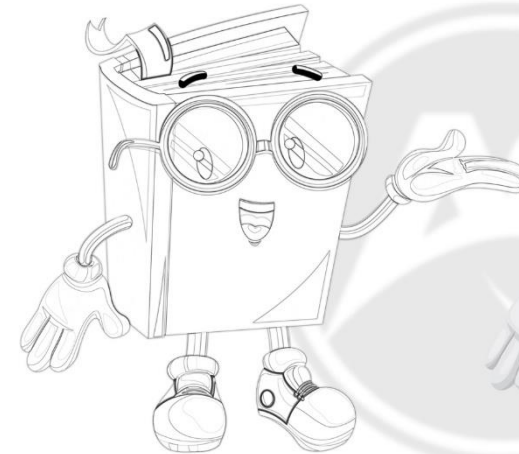



CG Production Services

Character Design , Promotional Videos , White board Ads





CG Production Services

Visual Presentations , Promotional Videos , White board Ads . Company profile videos



Company presentation providing an overview of its managed services

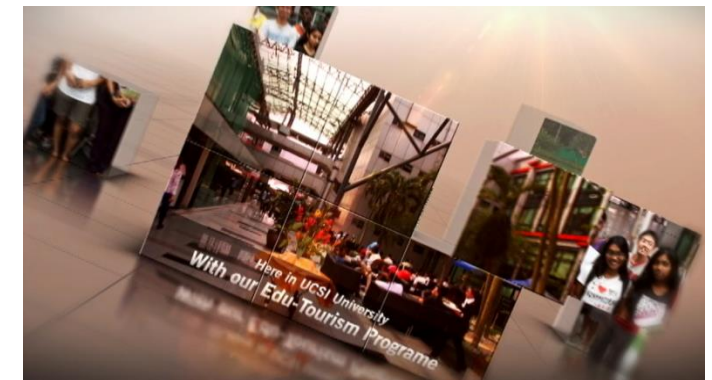
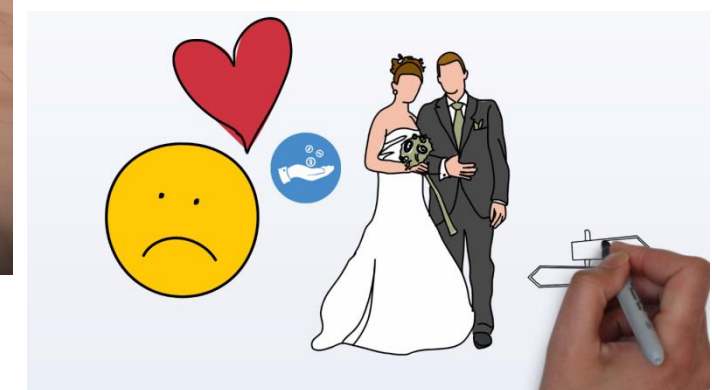



CG Production Services

Visual Presentations , Promotional Videos , White board Ads . Company profile videos

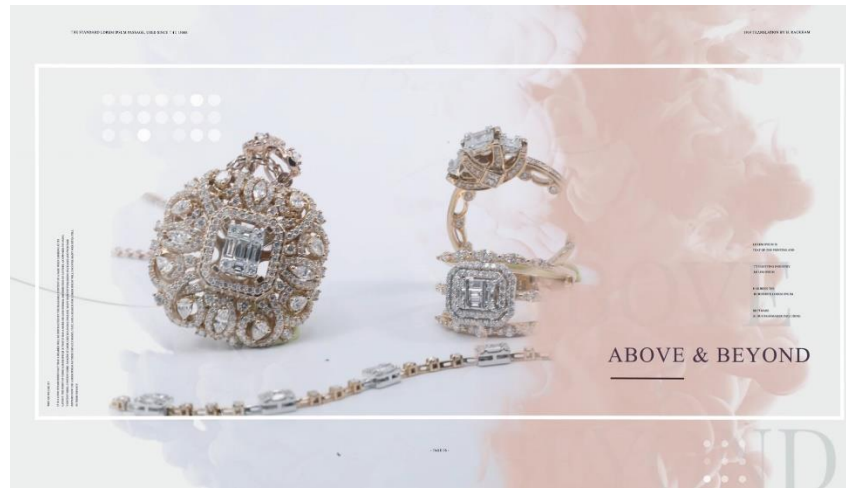
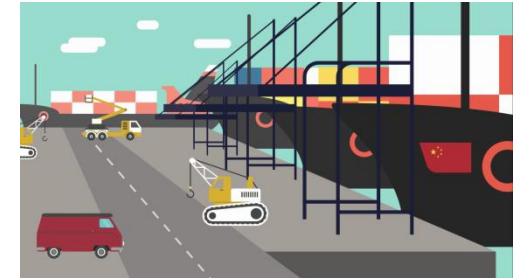
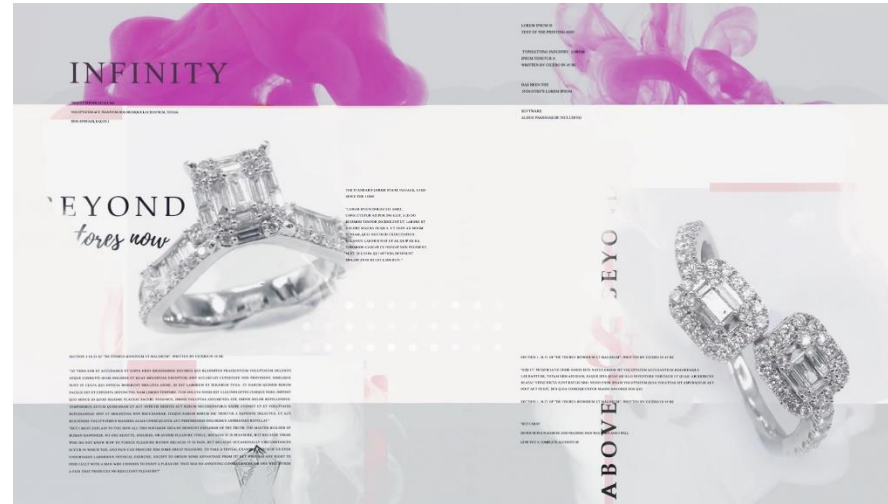



CG Production Services

Visual Presentations , Promotional Videos , White board Ads . Company profile videos



Pricing Table

Branding & Marketing Packages	CG Production Packages	Business Consulting & Development Packages
<p>Logo Design + Stationary 500 JOD</p>	<p>1 Minute Promotional video 250 JOD</p>	<p>Complete Business plan & Feasibility study 3500 JOD</p>
<p>Website Design 350 JOD Content Development & SEO 450 JOD</p>	<p>1 Minute Visual Presentation / Infographics / Whiteboard Ad. + Voice Over 450 JOD</p>	<p>Market & Industry Research 2500 JOD</p>
<p>Social Media Setup + Management 350 JOD per month</p>	<p>3D Production Camera Walk Through Modeling + Texturing & Lighting + Animation 60 JOD per Second for rendering + Post production Services</p>	<p>Transform your Business with blue ocean strategy + Complete Business Plan 5000 JOD</p>
<p>Full Branding Package 1000 JOD + Social Media Management 250 JOD per Month</p>	<p>Assets Modeling will be priced after reviewing the recommended designs</p>	<p>Marketing Study & campaigns design 1500 JOD</p>



Our Values

Why US



Efficiency

Our designs are tailored made and completely custom to fit your target markets.



Swiftness

Deadlines are very important to us, and with us they are never broken. In today's market, timing is everything, you plan the schedule and we will deliver.

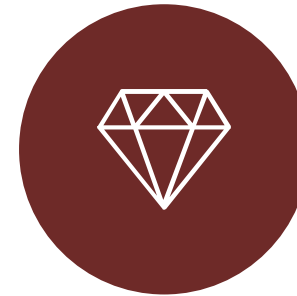

Pricing

Keeping it in the budget has been problem for everyone these days, we always try to keep in mind your budget and to adjust our services accordantly with no loss to final outcome.



Client List



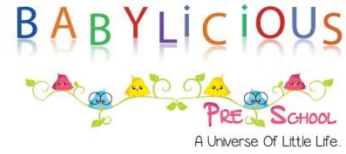

Abercrombie & Kent









AS-CONSULTANTS

BUSINESS CONSULTATION
MARKET RESEARCH & ANALYSIS
STRATEGY & INNOVATION



+962 799 054 762



Amin@as-consultants.org



ams.alr86@gmail.com

113-210 AREEJ COMMERCIAL COMPLEX - WASFI AL TAL ST.- TELA'A AL ALI - AMMAN, JORDAN